

# PRODUCT INFORMATION MODEL OD0821 ROCKfrog

© 2021 KURT BEIER & KATI QUINGER



Rope swinger without armrests



Single-Rope swinger, optionally with or without armrests



Rocking sofa, 2-seat optionally with or without armrests



Single-Rocking chair, optionally with or without armrests



Headrest individually & manually adjustable (Single-Chair & Sofa)



Back- & Footrest motorised adjustable until the relax position is reached.



Back- & Footrest motorised adjustable until the relax position is reached.

## 0821 ROCKfrog: MAGIC SWING

TAKE OFF OR STAY ON THE FLOOR ROCKING. BOTH IS POSSIBLE WITH OUR NEW FAVOURITE SOFA OR ARMCHAIR ROCKfrog. GENTLY ROCKING YOU CAN FIND YOUR PREFERRED POSITION WITH THE SMOOTH AND INFINITE ADJUSTMENT OF THE SEAT AND BACK SECTION. EACH SEAT ALONE AND YET TOGETHER. A PLACE TO RELAX AND LET GO.

**ROCKING CHAIR / SOFA:** THE ROCKING SKIDS ALLOW FOR A GENTLE SWING. THE INFINITELY, MOTORISED SEAT ADJUSTMENT LEADS UP TO THE "HEART BALANCE POSITION".

**ROPE SWING CHAIR / SOFA:** AT ANY TIME THE HANGING ROPE CAN BE ATTACHED TO THE ROCKfrog. THEN THE MOVEMENTS BECOME WIDER AND YOU BEGIN TO FLY. BODY AND MIND COME TO REST. EVEN NOW THE DESIRED BACK AND SEAT POSITION IS INFINITELY ADJUSTABLE. AN EYE-CATCHER OUTDOORS.

ROCKfrog IS AVAILABLE WITH OR WITHOUT ARMREST - AS DOUBLE OR SINGLE SEATER. UNIQUE PIECE PRODUCTION.



183F



230F



183F





230F

**Base frame:** metal, matt black fine structure powder-coated

**Attention! Maximum load:** 110 kg per seat

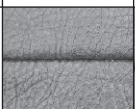
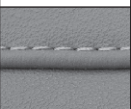
### Processing options of main seam / decorative seam

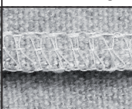
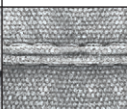
	Plain seam	Lap seam	KR* (zipper piping) extra charge	Overcast seam extra charge	Piping
					
Outdoor fabric	x		x		
Outdoor leather	x		x		

\*Zipper piping: optionally in the colours black, red, nature or light grey.

### Outdoor innercover

Additional protection against moisture penetration is provided by an inner cover made of waterproof fabric. The inner cover can be selected for the respective model at an extra charge.

Please specify when ordering.

### Locking package for rocking skid lock:

- Feet + assembly accessories FP

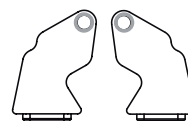

2 x back side feet

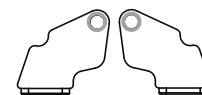

2 x front side feet

### Ceiling mounting material for rope swing (specify when ordering) optionally:

- Concrete ceiling attachment\* **SPB or**
- Wood ceiling attachment\* **SPH**

### Delivery scope, package for rope swing:

Consisting of:

- Fixing material **concrete or wood** (depending on order)
- Plastic coated wire rope: 4 pieces
- Ceiling mountings incl. carabines: 2 pieces
- Suspension bolt: 8 pieces
- 1 x Drilling template

\* The ceiling fastening is galvanised metal as standard. For damp rooms such as wellness areas or in salty climates, the ceiling fastenings can be ordered in V2A or V4A at an extra charge. **Please specify with order.**

Ceiling height: 230-250 cm

Floor distance: min. 4 cm

5 adjustment possibilities in 5 cm steps:

Possible ceiling heights: 230/235/240/245/250. Attention! A floor distance of 4 cm or more must be ensured.



Model OD0821 ROCKfrog is also available as indoor product!

For further informations refer to product information 0821 ROCKfrog.



Rocking skid: metal, matt black fine structure powder-coated



Rocking skid with rope: metal, matt black fine structure powder-coated

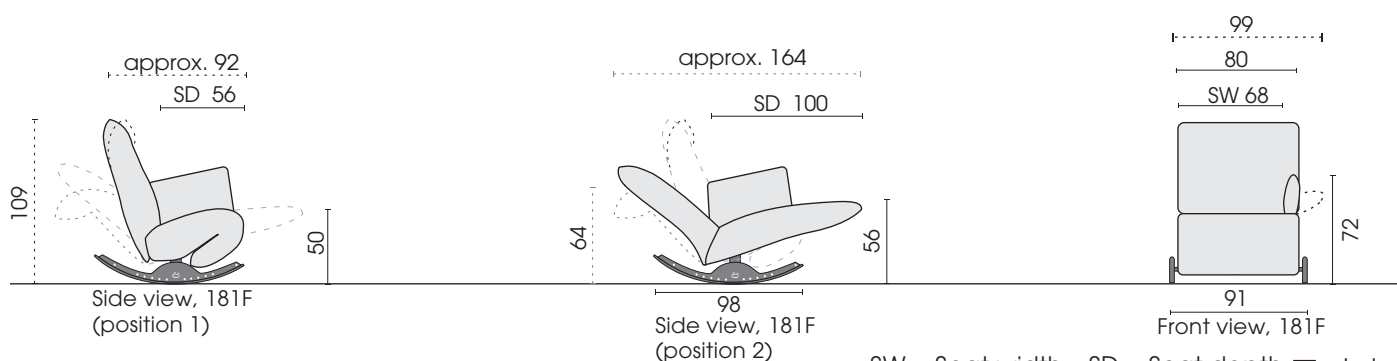

SW = Seat width SD = Seat depth □ = Label

## Rocking elements with function

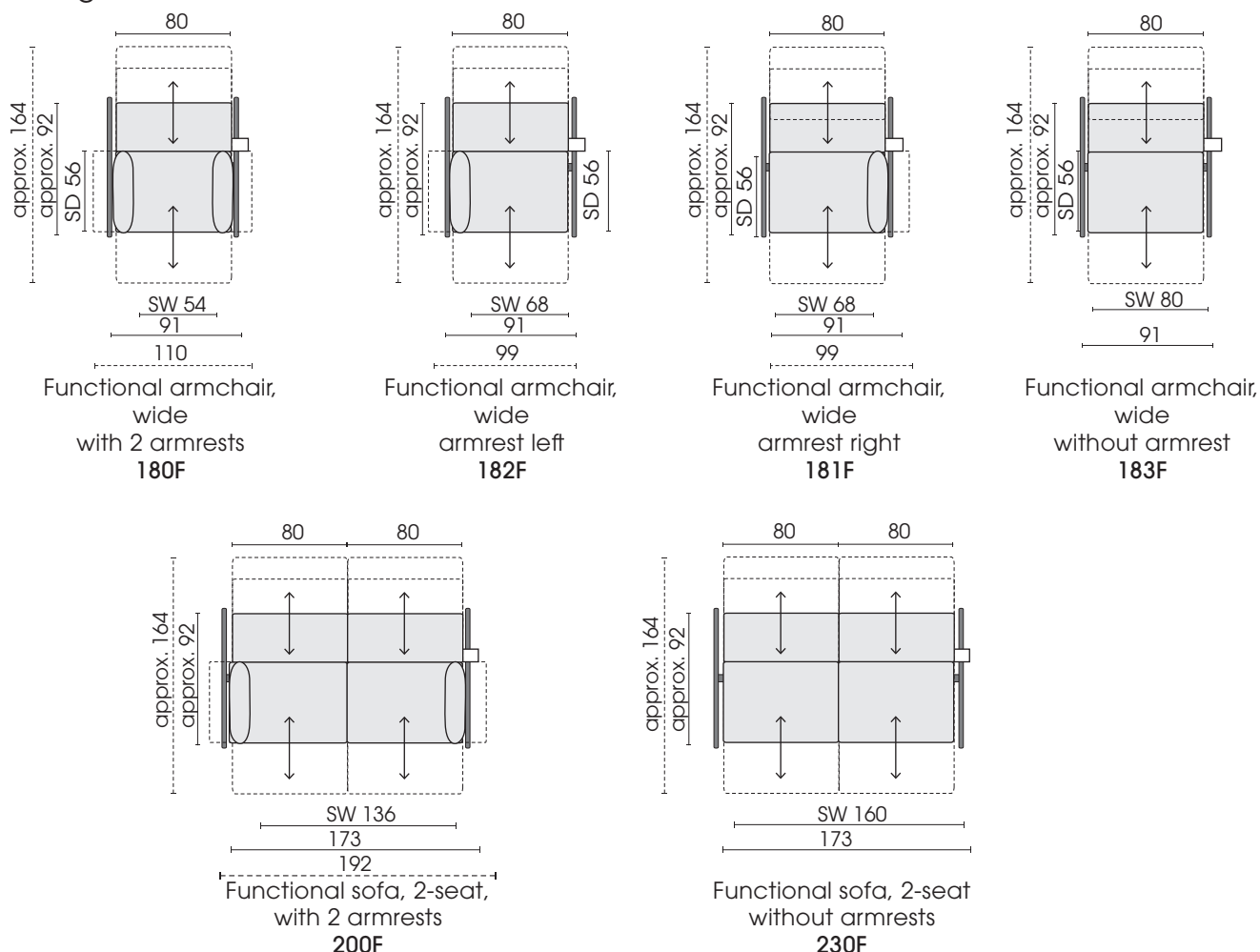

### Standard version for motorised drive:

- wireless remote control
- power supply



**Wireless remote control:  
Warning of magnetic field.**

Optionally with battery for an extra charge.

### Protective covers (waterproof):

Protective cover for type 180F: SH180F

Protective cover for type 181F: SH181F

Protective cover for type 182F: SH182F

Protective cover for type 183F: SH183F

Protective cover for type 200F: SH200F

Protective cover for type 230F: SH230F

Each piece of furniture is handmade and unique. Deviations to the listed measurements may be caused by:  
1. different upholstery materials (fabric, leather), 2. processing of ticking mats, 3. the pressure to combine individual parts, etc.  
The seat comfort of a sofa type with larger seat depth usually differs from one with lower depth.